

Features

Package	Higher reliability with using silicone resin Outer dimension: 1.6 x 0.8 x 0.7mm (L x W x H)
Product features	<ul style="list-style-type: none"> •Equivalent to JEDEC level 2a •Chromaticity coordinates typ. $x = 0.316, y = 0.316$ •Consideration of IF derating is unnecessary until 85°C •Lead-free soldering compatible •RoHS2 compliant

Recommended applications

- Light source for Automotive interior, various indicators etc.

Outline dimensions

VCKW1151CDS-3C6L3-TR

Unit : mm
 Weight : 1.4mg
 Tolerance : ±0.1

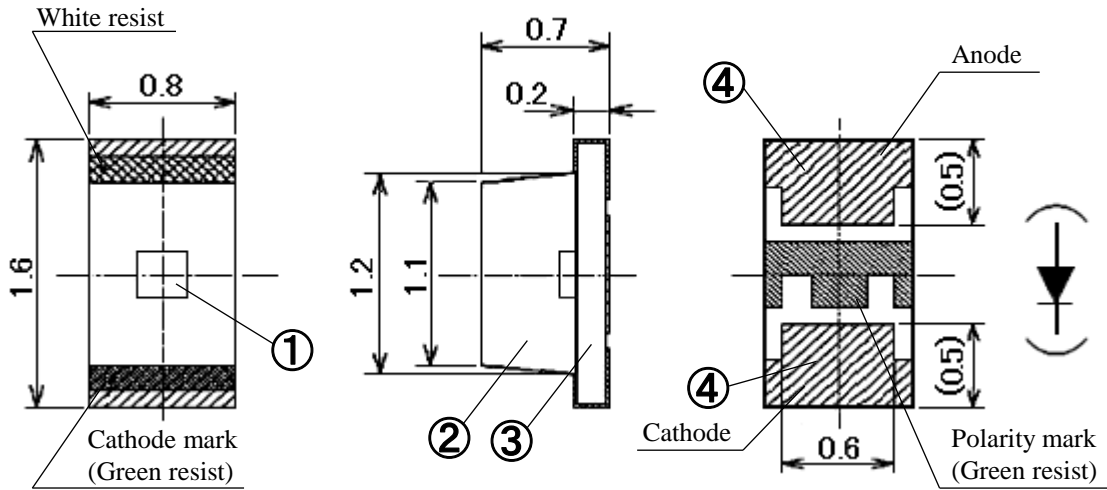

No.	Part name	Material	Qty.
①	LED die	InGaN	1
②	Mold resin	Silicone resin	1
③	Substrate	Glass fabrics	1
④	Electrode	Cu / Au plating	2

Recommended soldering pad

Note

- ※1 : The cutting burr size of the substrate and pin isn't contained in the size of the height of the product.
- ※2 : Please note no short-circuit when the wiring pattern is arranged between the soldering attachment pad.

Unit : mm

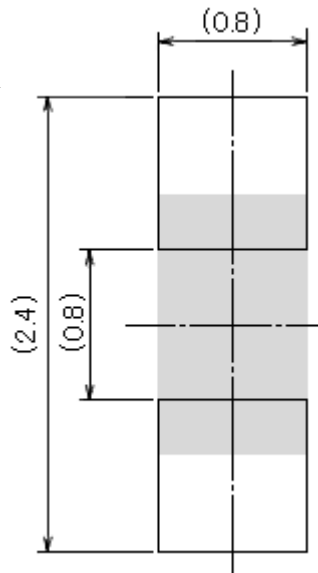

Specifications

VCKW1151CDS-3C6L3-TR

【 Product overview 】

Die material	InGaN
Emitting color	White
Resin color (emitting area)	Difused pale yellow

【 Absolute maximum ratings 】

(Ta=25°C)

Item	Symbol	Maximum ratings	Units
Power dissipation	P_d	88.8	mW
Forward current	I_F	25	mA
Repetitive peak forward current "1ms, 1/10duty"	I_{FRM}	100	mA
I_F Derate linearly from "85°C"	ΔI_F	1.0	mA/°C
I_{FRM} Derate linearly from "85°C"	ΔI_{FRM}	4.0	mA/°C
Reverse voltage	V_R	5	V
Operating temperature	T_{opr}	-40 to +100	°C
Storage temperature	T_{stg}	-40 to +110	°C
Electrostatic discharge threshold "HBM"	ESD	1,000	V
Soldering temperature "reflow soldering"	T_{sld}	260	°C
Junction temperature	T_j	125	°C

Notes 1

Notes 2

Notes 1 ESD testing method : EIAJ4701/300(304) Human Body Model(HBM) 1.5kΩ, 100pF

Notes 2 Please refer to the attached sheets page 9, Soldering Conditions.

【 Thermal characteristics 】

(Ta=25°C)

Item	Symbol	Typ.	Units
Thermal resistance 【Junction - ambient】	$R_{th(j-a)}$	450	°C/W
Thermal resistance 【Junction - solder point】	$R_{th(j-s)}$	300	°C/W

Notes 3

Notes 3 $R_{th(j-a)}$ Measurement condition
 • Substrate : FR4 (t=1.6mm)
 • Pattern size : 16mm²

Specifications

VCKW1151CDS-3C6L3-TR

【 Electro-optical characteristics 】

(Ta=25°C)

Item	Symbol	Conditions	Min.	Typ.	Max.	Units	
Forward voltage	V_F	$I_F = 20mA$	2.6	3.3	3.5	V	Notes4
Reverse current	I_R	$V_R = 5V$	-	-	10	μA	
Luminous intensity	I_V	$I_F = 20mA$	270	350	470	mcd	Notes5
Luminous flux	Φ_V	$I_F = 20mA$	-	1,850	-	mlm	
Chromaticity coordinates	x	$I_F = 20mA$	-	0.316	-		Notes6
	y		-	0.316	-		
Half intensity angle	$\Delta\theta_x$	$I_F = 20mA$	-	160	-	deg.	Notes7
	$\Delta\theta_y$		-	168	-	deg.	

Notes4 Tolerance:±0.1V

Notes5, 6 Please refer to the attached sheets, each sorting chart.

Notes6 Chromaticity coordinates ; x and y according to CIE1931

Notes7 Viewing angle at 50% I_V , $\Delta\theta_x$; Housing long side axis, $\Delta\theta_y$; Housing short side axis

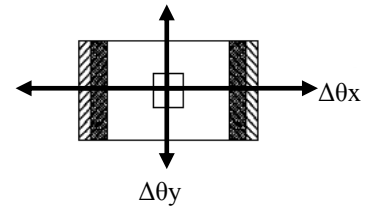

【 Sorting chart for luminous intensity I_V 】

LEDs shall be sorted out into the following chart and each rank parts shall be packed separately when shipping.

Rank	Luminous intensity I_V (mcd)		Condition
	Min.	Max.	
C6	270	330	$I_F = 20mA$ $T_a = 25^\circ C$
C7	330	390	
C8	390	470	

Notes : Luminous intensity tolerance each rank: ±10%

Specifications

VCKW1151CDS-3C6L3-TR

【 Sorting chart for chromaticity coordinates, x,y 】

LEDs shall be sorted out into the following chart and each rank parts shall be packed separately when shipping.

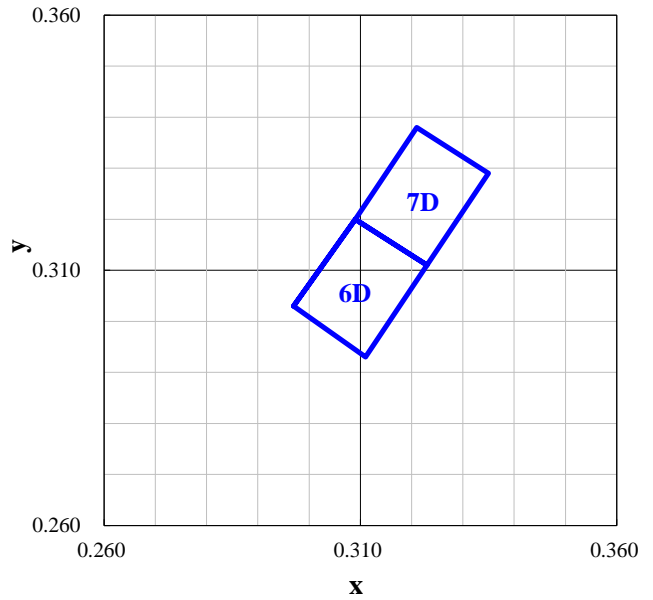
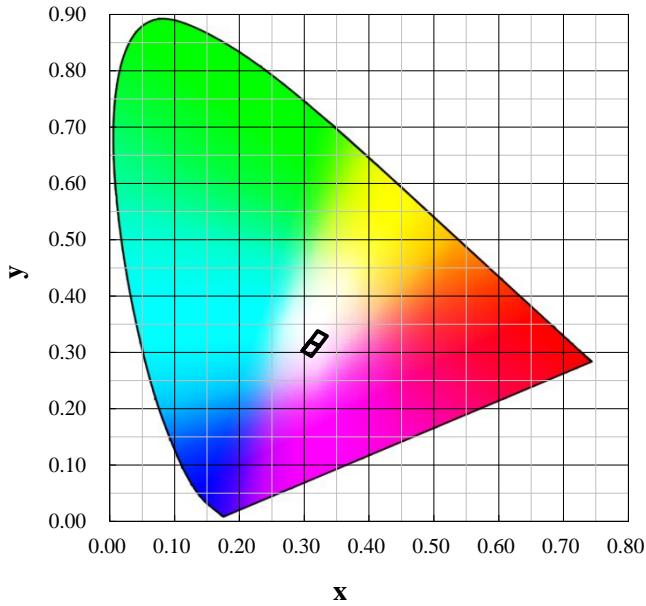

$I_F = 20\text{mA}, T_a = 25^\circ\text{C}$

Rank	Left down		Left upper		Right upper		Right down	
	x	y	x	y	x	y	x	y
6D	0.297	0.303	0.309	0.320	0.323	0.311	0.311	0.293
7D	0.309	0.320	0.321	0.338	0.335	0.329	0.323	0.311

Notes : Chromaticity coordinates tolerance each rank ; ± 0.01

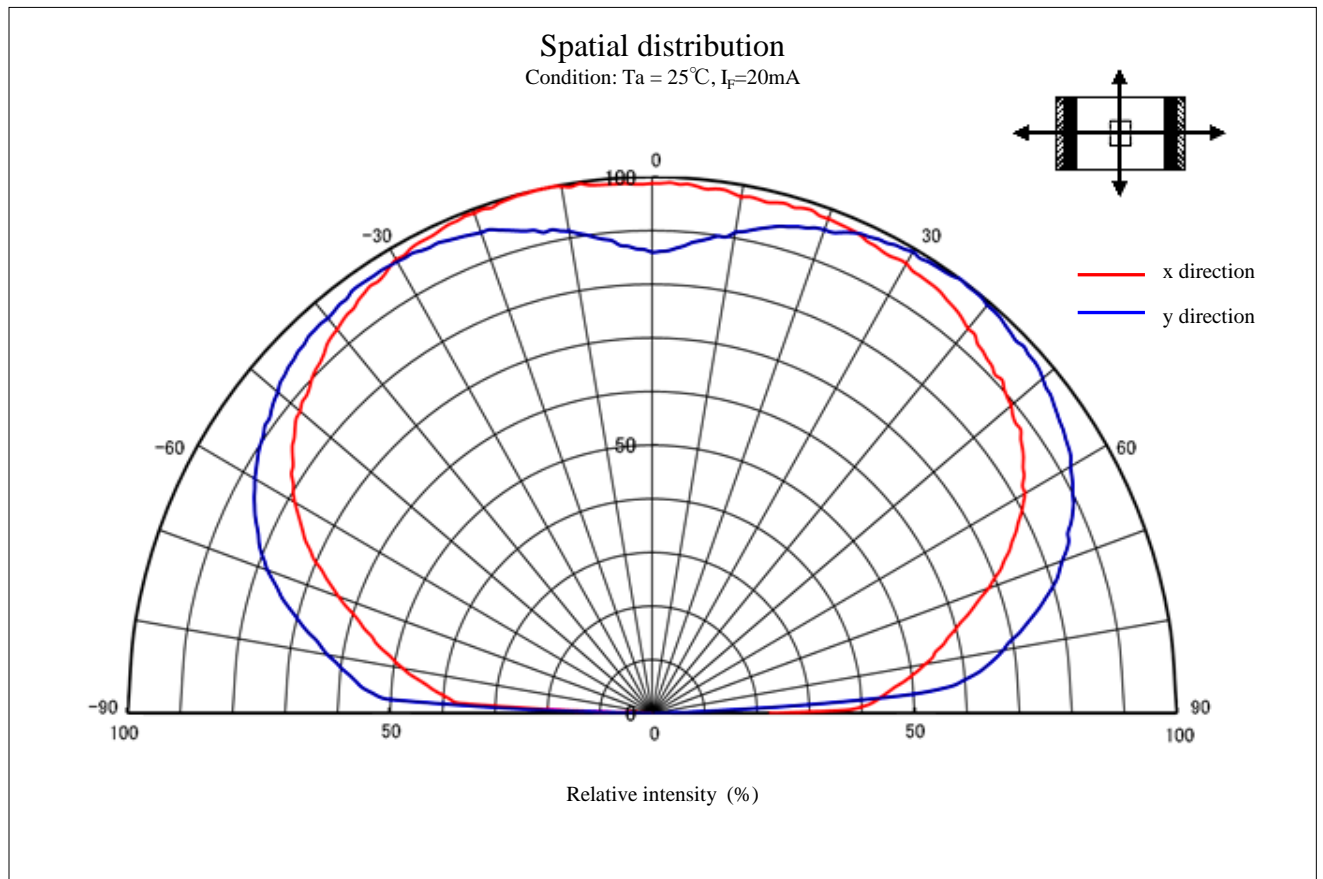
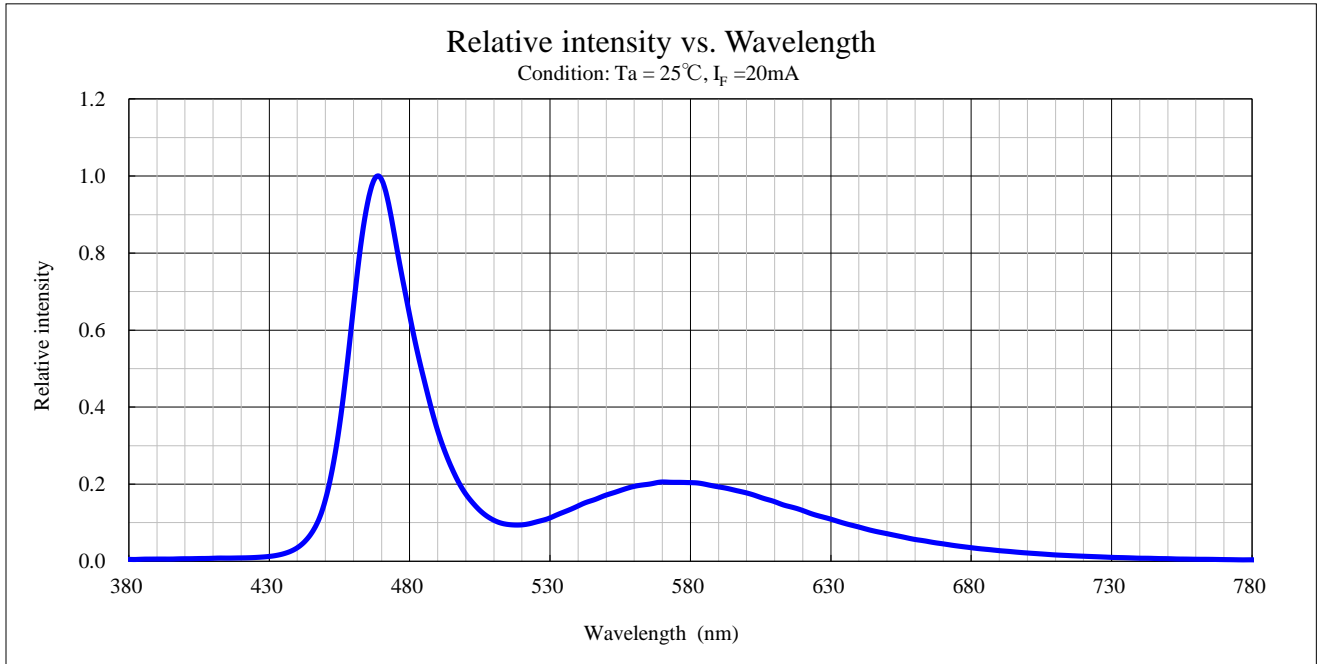

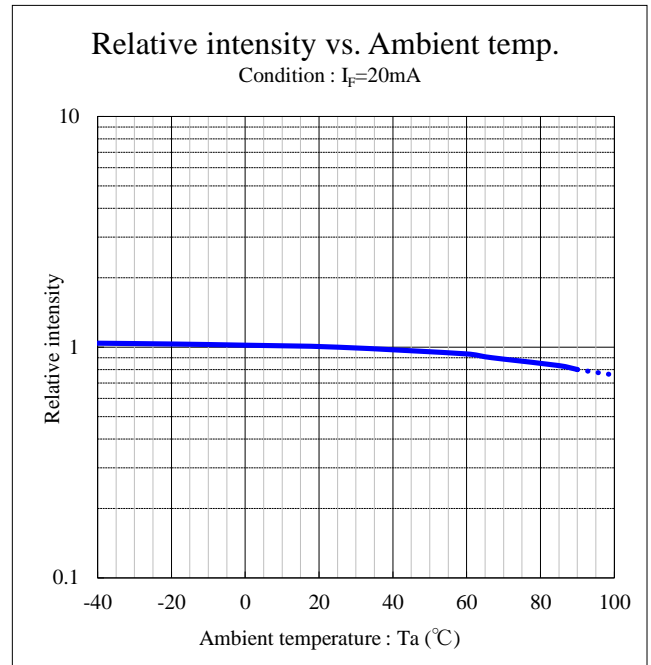
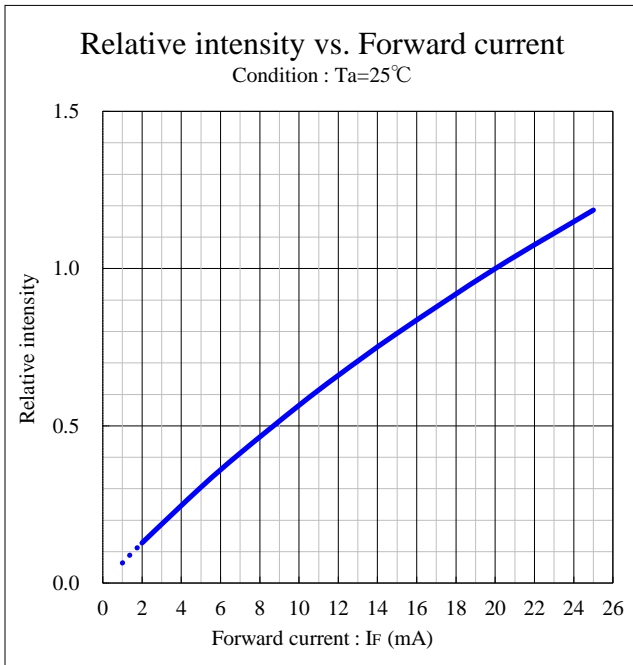
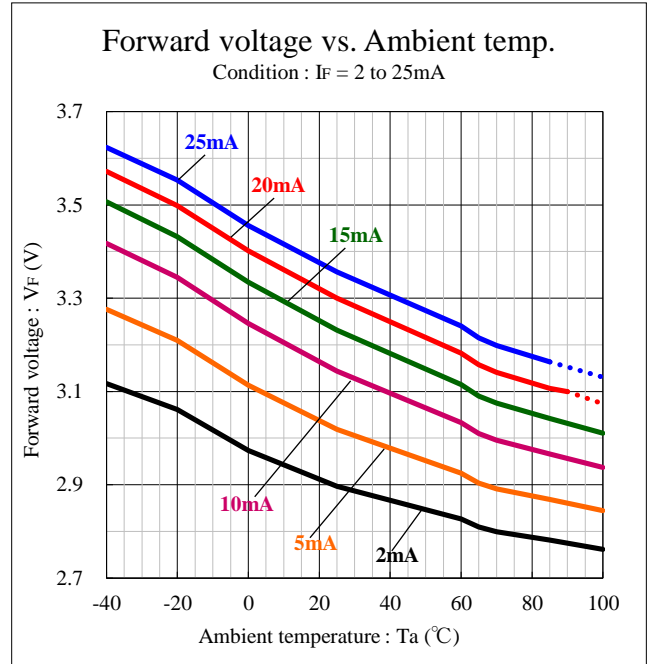
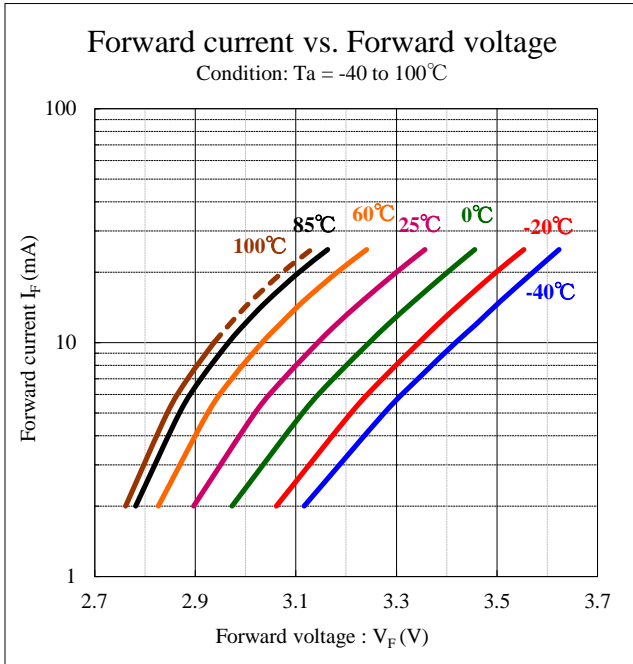

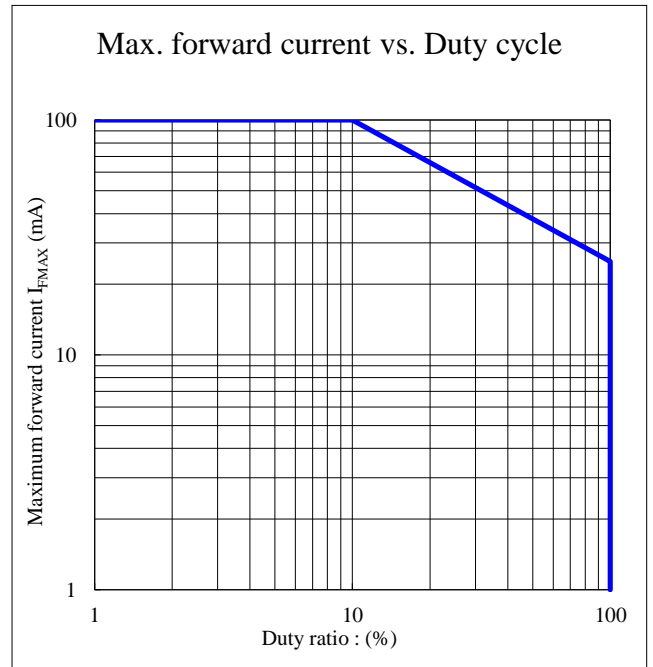
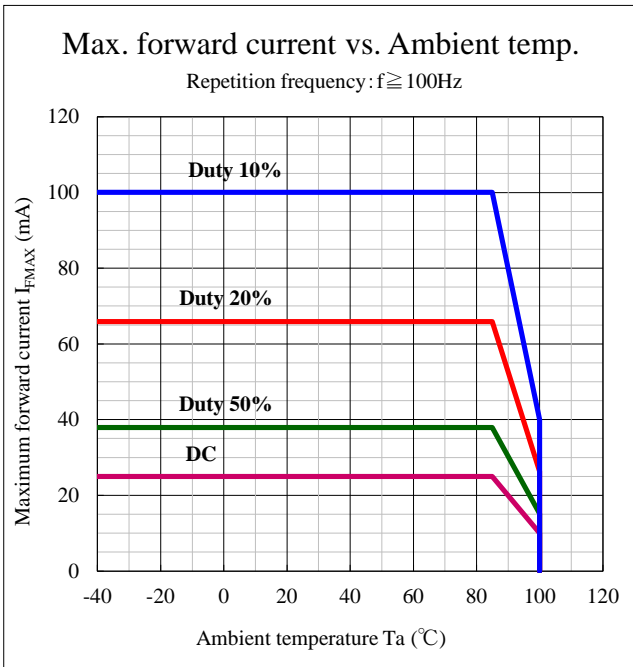
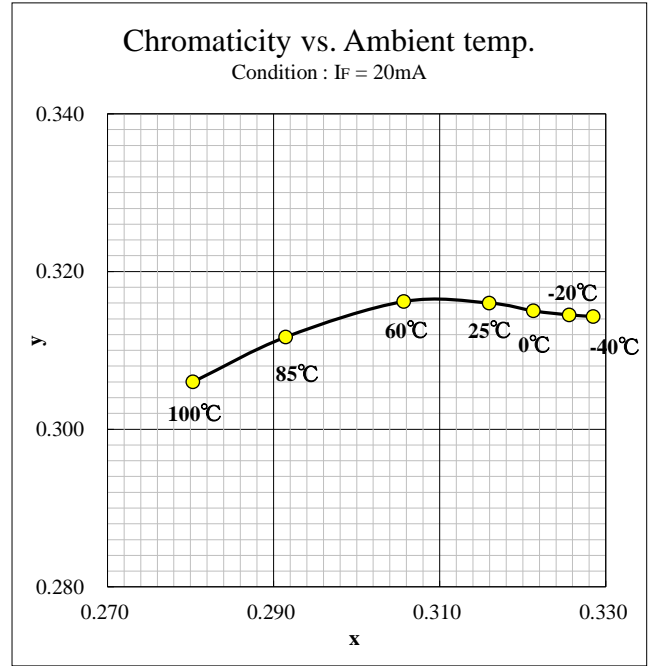
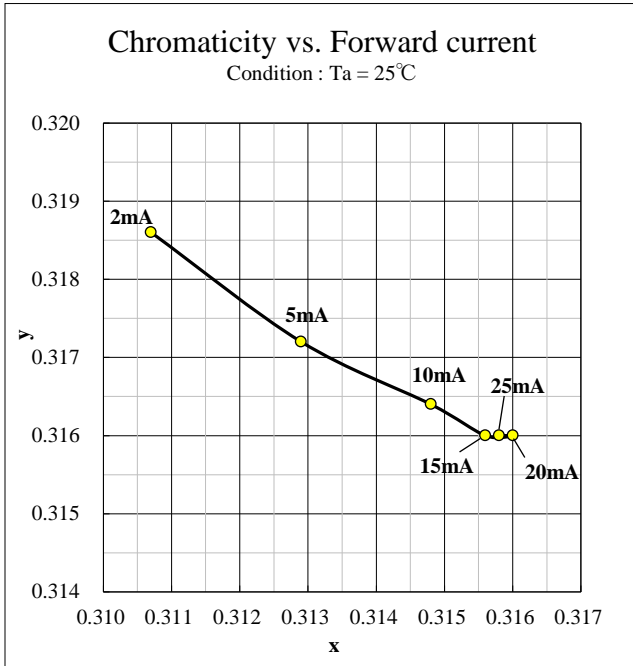

【Soldering precaution】

(acc.to EIAJ-4701/300)

1. Heat stress during soldering will influence the reliability of LEDs, however that effect will vary on heating method. Also, if components of varying shape are soldered together, it is recommended to set the soldering pad temperature according to the component most vulnerable to heat (e.g., surface mount LED).
2. LED parts including the resin are not stable immediately after soldering (when they are not at room temperature), any mechanical stress may cause damage to the product. Please avoid such stress after soldering, especially stacking of the boards which may cause the boards to warp and any other types of friction with hard materials.
3. High hardness silicone resin is used for this product's lens, but the silicone resin has the characteristic that softens at the high temperature. There is a possibility of causing the transformation, the breakage, and peeling off of the lens when it touches the resin lens at the high temperature such as immediately after soldering. Please avoid touching the lens at the high temperature.
4. Recommended temperature profile for the Reflow soldering is listed as the temperature of the resin surface. Temperature distribution varies on heating method, PCB material, other components in the assembly, and mounting density . Please do not repeat the heating process in Reflow process more than twice.

【Recommended reflow soldering condition】

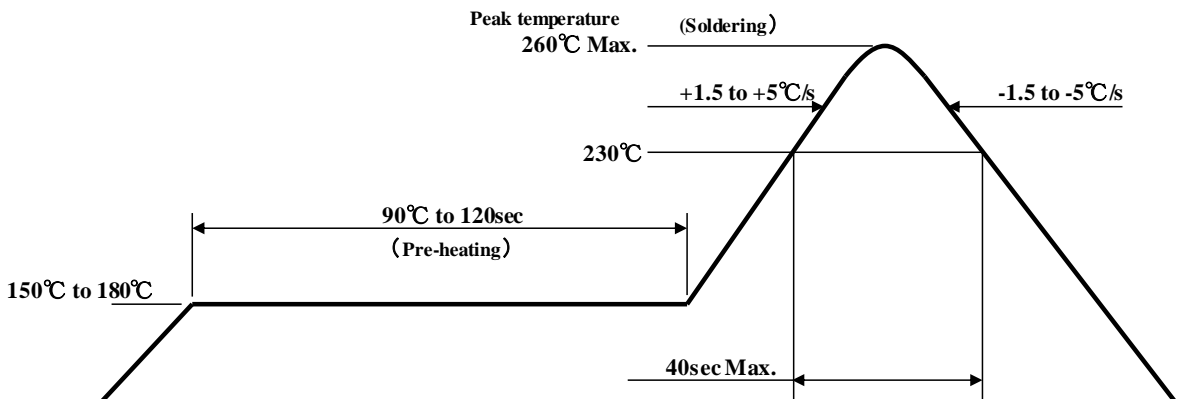

Notes 1 Temperature Profile for the reflow should be set to the surface temperature of resin which is on the top of LED. This should be the maximum temperature for soldering. Lowering the heating temperature and decreasing heating time is very effective in achieving higher reliability.

Notes 2 The reflow soldering process should be done up to twice(2 times Max). When second process is performed, interval between first and second process should be as short as possible to prevent absorption of moisture to resin of LED. The second soldering process should not be done until LEDs have returned to room temperature (by nature-cooling) after first soldering process.

Soldering condition

VCKW1151CDS-3C6L3-TR

5. If soldering manually, Stanley recommends using a soldering iron equipped with temperature control. During the actual soldering process, make sure that the soldering iron never touches the LED itself, and avoid the LED's electrode heating temperature reaching above the heating temperature of the solder pad. All repairs must be performed only once in the same spot, and please avoid reusing components.
6. In soldering process, immediately after iron tip is cleaned, please make sure that the soldering iron reaches the appropriate temperature, before using. Also, please avoid applying any types of pressure to the soldered components before the solder has been cooled and hardened, as it may deteriorate solder performance and solder quality.

【Recommended manual soldering condition】

Temperature of iron tip	350°CMax.
Soldering duration, time	3sec.Max., 1 time

7. When using adhesive material for tentative fixatives, thermosetting resin or Ultraviolet radiation (UV) setting resin with heat shall be recommended.
8. When cleaning, isopropyl alcohol shall be recommended. Some chemicals, including Freon substitute detergent could corrode or affect the optical characteristics of the lens or the casing surface. Please review the reference chart below for cleaning. Cleaning with ultrasonic shall not be recommended.
9. Flow soldering (dip soldering) is not recommended for this product.

Cleaning agents	Recommended / Not recommended
Isopropyl alcohol	✓ Recommended
Trichloroethylene	x Not recommended
Chloroethene	x Not recommended
Acetone	x Not recommended
Thinner	x Not recommended

【For Electric Static Discharge (ESD)】

InGaN die LEDs are sensitive to voltage surges generated by On/Off status change and friction with synthetic materials, which may cause severe damage to the die or undermine its reliability. Damaged products may experience conditions such as extremely high reverse voltage or decrease of forward rise voltage deteriorating their optical characteristic. Stanley InGaN products are packed with anti-static components. However, the following precautions must be taken into account upon product shipment.

1. Electrification / static electricity protection

In order to avoid product (die) damage from static electricity caused by electrified operator and other materials electrified friction coming in contact with the product, Stanley recommends taking the following precautions.

- ① Do not place electrified non-conductive materials near the LED product.
Avoid LED products from coming into contact with metallic materials.(Should the metallic material be electrified , the sudden surge voltage will most likely damage the product.)
- ② Avoid a working process which may cause the LED product to rub against other materials.
- ③ Install ground wires for any equipment, where they can be installed, with measures to avoid static electricity surges.
- ④ Prepare a ESD protective area by placing a Conductive Mattress (1MΩ MAX.) and Ionizer to remove any static electricity.
- ⑤ Operators should wear a protective wrist-strap.
- ⑥ Operators should wear conductive work-clothes and shoes.
- ⑦ To handle the products directly, Stanley recommends the use of ceramic, and not metallic, tweezers.

2. Working environment

- ① Dry environment is more likely to cause static electricity. Although a dry environment is ideal for storage state of LED products, Stanley recommends an environment with approximately 50% humidity after the soldering process.
- ② Recommended static electricity level in the working environment is less than 150V, which is the same value as Integrated Circuits (which are sensitive to static electricity).

【Handling precautions for product mounting】

<Recommendation>

Load : less than 10N **(to avoid product breakage)**

- ※ During mounting, because of the mounter nozzle's load and shape, the lens may break and the shape may change. Therefore, please adjust the load / nozzle adsorption point and the nozzle diameter before use. Moreover, since the occurrence of product remnants of the nozzle part is possible, please adjust the conditions before vacuum break or air discharge.
- ※ Not just the nozzle, but also regarding other tools/instruments/parts, please do not put pressure on the lens.

【Other precautions】

1. The products are designed to achieve higher performance reliability, however, they can be influenced by usage conditions.
2. Absolute maximum ratings are set to prevent LED products from failing due to excess stress (temperature, current, voltage, etc.). These ratings must never be overrun even for a moment.
3. To achieve the highest performance reliability, it is necessary to take into account, factors such as forward voltage adjusted to the usage temperature condition, derating of the power consumption, and other variable factors.
4. Please insert Straight Protective Resistors into the circuit in order to stabilize LED operation and to prevent the device from igniting due to excess current.
5. Please avoid to stick foreign material because molding resin in the products has adhesiveness. And please don't touch lens portion.
6. Please check the actual performance in the assembly because the Specification Sheets are described for LED device only.
7. Please refrain from looking directly at the light source of LED at high output, as it may harm your vision.
8. The products are designed to operate without failure in recommended usage conditions. However, please take the necessary precautions to prevent fire, injury, and other damages should any malfunction or failure arise.
9. The products are manufactured to be used for ordinary electronic equipment. Please contact our sales staff beforehand when exceptional quality and reliability are required, and the failure or malfunction of the products might directly jeopardize life or health (such as for airplanes, aerospace, transport equipment, medical applications, nuclear reactor control systems and so on)..
10. When there is a process of supersonic wave welding etc. after mounting the product, there is a possibility of affecting on the reliability of junction part in package (junction part of die bonding and wire bonding). Please use after affirming beforehand there is no problem.
11. The formal specification sheets shall be valid only by exchange of documents by both parties.

This products are baked (moisture removal) before packaging, and are shipped in moisture-proof packaging (as shown below) to minimize moisture absorption during transportation.
 However, in regards to storing the products, the use of dry-box under the following conditions is recommended.
 Moisture-proof bag as the packaging is made of anti-static material but packaging box is not.

【Recommended storage condition / products warranty period】

Temperature	+5~30°C
Humidity	Under 70%

In the case of the package unopened , **6 months under 【 Recommended storage condition 】**.
 Please avoid rapid transition from low temp. condition to high temp. condition and storage in corroding and dusty environment.

【Time elapsed after package opening】

The package should not be opened until immediately prior to its use,
 and please keep the time frame between package opening and soldering which is **【maximum 672h.】**
 If the device needs to be soldered twice, both soldering must be completed within 672h.

If any components should remain after their use, please seal the package and store them under the conditions Described in the **【 Recommended storage condition 】**.

The product must be required to perform baking process (moisture removal)
 for **at least 10h and not exceed for 12h , at 60+/-5 degrees Celsius** if following conditions apply.

1. In the case of color of indicators (those are in the package of desiccant) change or lose its blue color.
2. In the case of time is passed for 672h after the package is opened once.

Please backing process must be performed after putting out from package.

Baking may be performed in the tape-reel form, however if it is performed with the reel stacked over one another, it may case deformation of the reels and taping materials, which may cause problems during production.
 Please make sure that the product has cooled to normal temperature after performing the baking process.
 Provided that, baking process shall be 2 times MAX.

【Moisture-proof packaging specification】

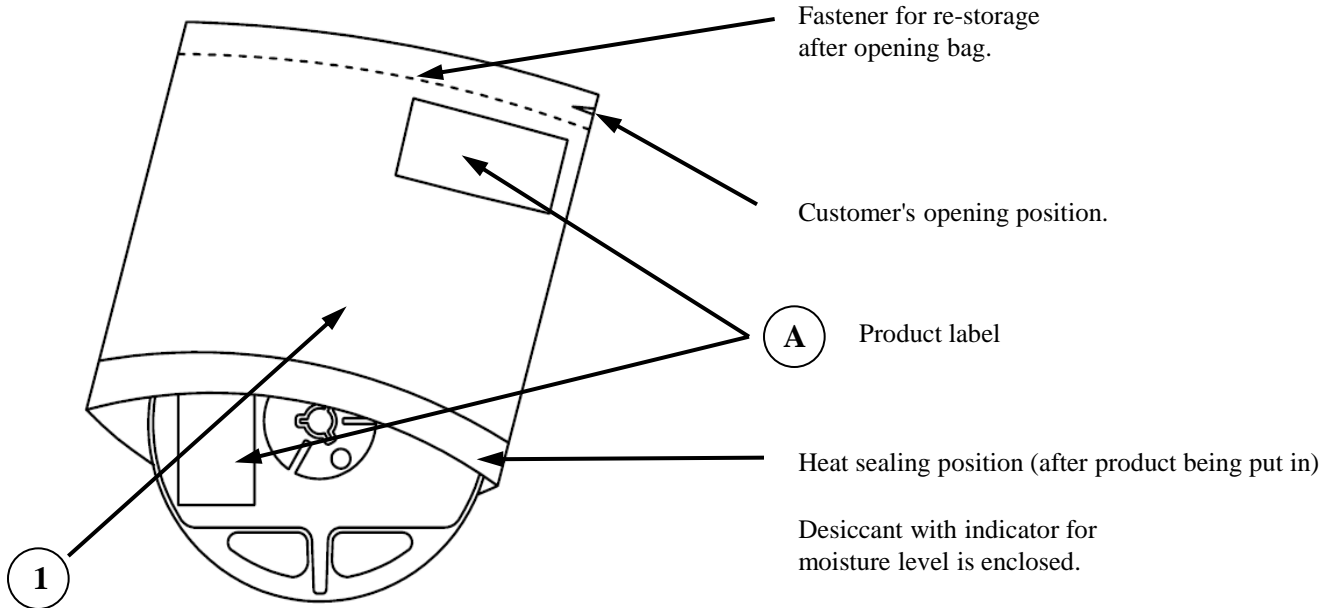

NO.	Part name	Material	Remarks
①	Moisture-proof bag with Aluminum layer	PET+Al+PE	with ESD protection

【Flow chart-package opening to mounting】

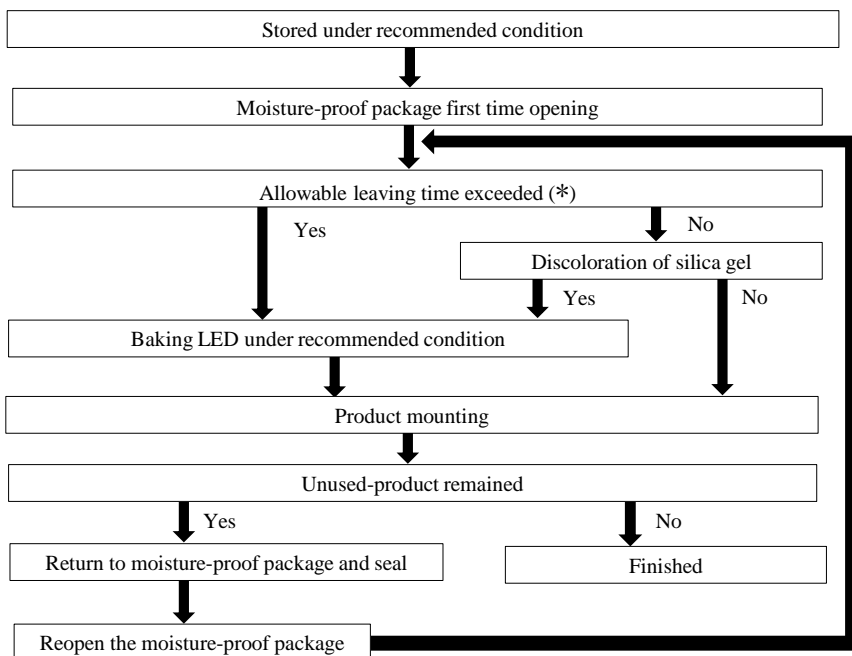

Allowable leaving time means the maximum allowable leaving time after opening package, which depends on each LED type. The allowable leaving time should be calculated from the first opening of package to the time when soldering process is finished. When judging if the allowable leaving time has exceeded or not, please subtract the soldering time. The allowable leaving time after reopening should be calculated from the first opening of package, or from the time when baking process is finished.

Packaging specifications

VCKW1151CDS-3C6L3-TR

【Packing box】

(RoHS2 / ELV Compliant)

Box type	Outline dimension L x W x H (mm)	Capacity of the box
Type A	280 x 265 x 45	3 reels
Type B	310 x 235 x 265	15 reels
Type C	440 x 310 x 265	30 reels

The above measure is all the reference value.

The box is selected out of the above table by shipping quantity.

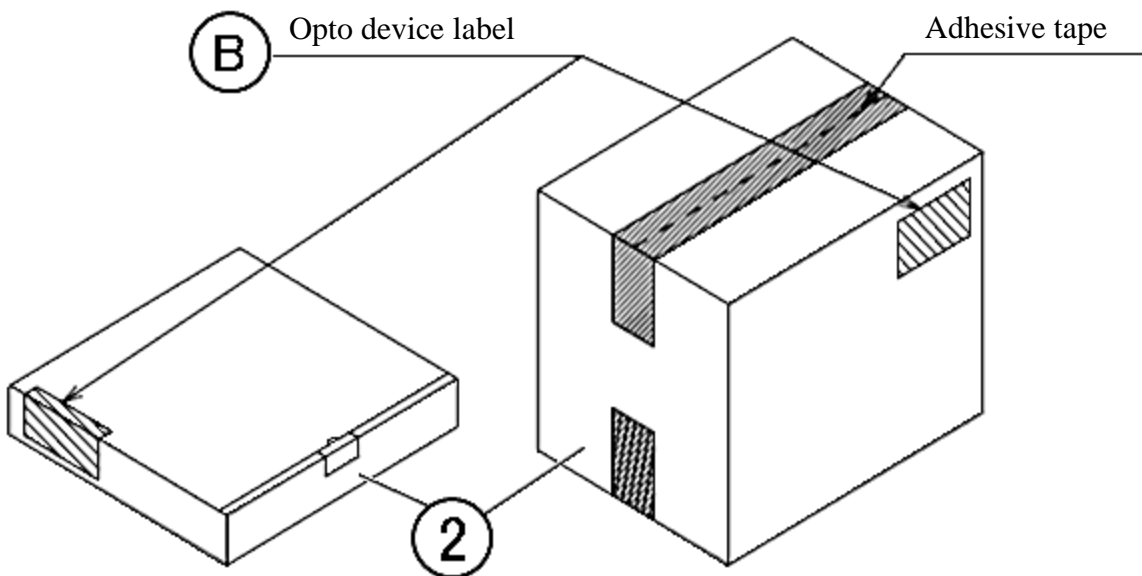

Type A

Material / box : Cardboard C5BF

Type B,C

Material / box : Cardboard K5AF

Partition : Cardboard K5AF

No.	Part name	Material	Remarks
②	Packing box	Corrugated cardboard	without ESD protection

【Label specification】

(acc.to JIS-X0503(Code-39))

A Product label

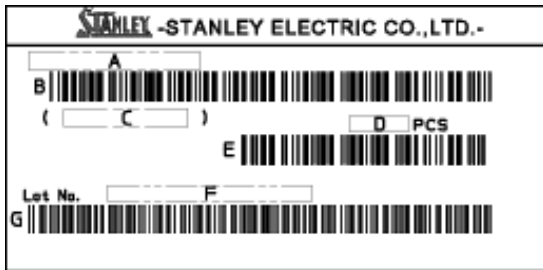

- A. Parts number
- B. Bar-code for parts number
- C. Parts code (In-house identification code for each parts number)
- D. Packed parts quantity
- E. Bar-code for packed parts quantity
- F. Lot number & rank
(refer to lot number notational system for details)
- G. Bar-code for lot number & rank

B Opto device label

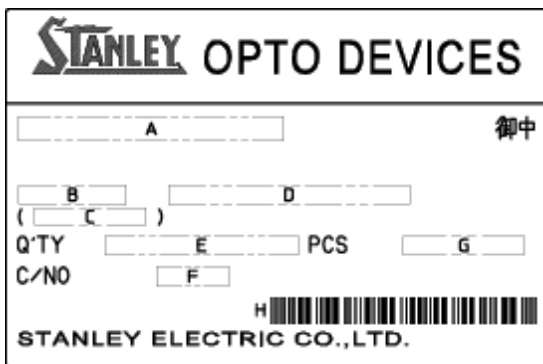

- A. Customer name
- B. Parts type
- C. Parts code
- D. Parts number
- E. Packed parts quantity
- F. Carton number
- G. Shipping date
- H. Bar-code for In-house identification number

<Remarks> Bar-code font : acc.to Code-39(JIS-X0503)

Taping and reel specifications

VCKW1151CDS-3C6L3-TR

(acc.to JIS-C0806-03)

【Appearance】

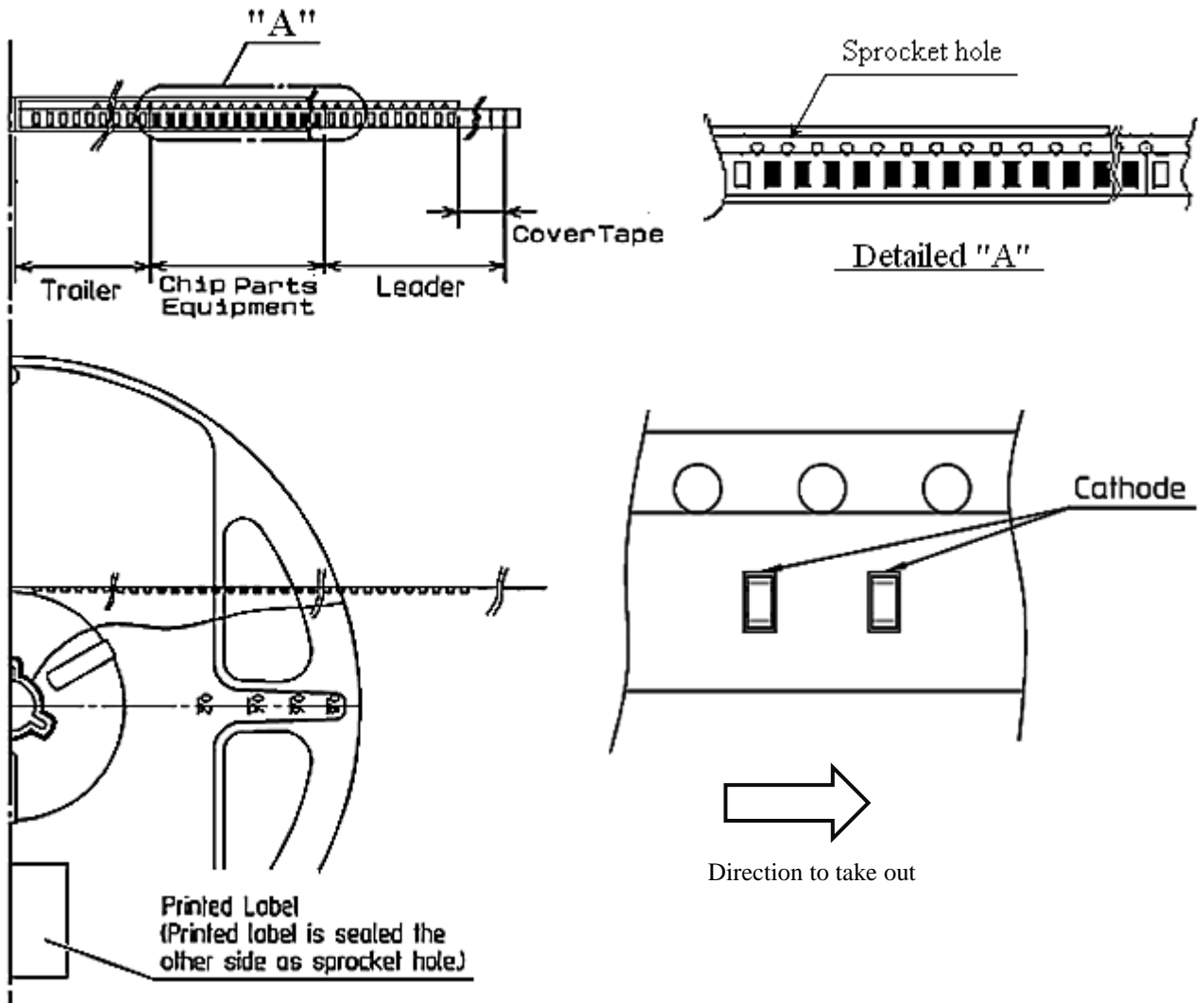

Note

"-TR" means Cathode Side of LEDs should be placed on the sprocket-hole side.

Items		Specifications	Remarks
Leader area	Cover-tape	Cover-tape shall be longer than 300mm without carrier-tape	The end of cover-tape shall be held with adhesive tape.
	Carrier-tape	Empty pocket shall be more than 25 pieces.	Please refer to the above figure for Taping & reel orientation .
Trailer area		Empty pocket shall be more than 40 pieces.	The end of taping shall be inserted into a slit of the hub.

Taping and reel specifications

VCKW1151CDS-3C6L3-TR

(acc.to JIS-C0806-03)

【 Qty. per reel】

4,000 parts/reel

※ Minimum qty. per reel might be 500 parts when getting less than 4,000 parts.

In such case, parts of 500-unit-qty. shall be packed in a reel and the qty. shall be identified on the label.

【Mechanical strength】

Cover-tape adhesive strength shall be 0.1 ~ 1.0N (An angle between carrier-tape and cover-tape shall be 170 deg.).

Both tapes shall be so sealed that the contained parts will not come out from the tape when it is bent at a radius of 15mm.

【 Others】

- Reversed-orientation, up-side down placing, side placing and out of spec. parts mix shall not be held.
- Max qty. of empty pocket per reel shall be defined as follows.

Qty. / reel	Max. qty. of empty pockets	Remarks
~500	1	-
~1,000	1	-
~1,500	2	-
~2,000	2	No continuance
~2,500	3	No continuance
~3,000	3	No continuance
~3,500	4	No continuance
~4,000	4	No continuance

Lot number notational system

VCKW1151CDS-3C6L3-TR

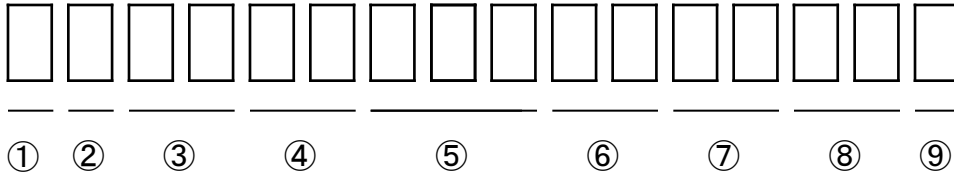

① - 1digit : Production location (mark identify alphabet)

② - 1digit : Production year (the last digit of production year 2020→0, 2021→1, 2022→2, 2023→3 …)

③ - 2digits : Production month (Jan. to Sep. ,should be 01,02,03 …)

④ - 2digits : Production date

⑤ - 3digits : Serial number

⑥ - 2digits : Tape and reel following number

⑦ - 2digits : Radiant intensity rank.

(If radiant intensity rank is 1 digit, "-" shall be dashed on the place for the second digit.
If there is no identified intensity rank, "- -" is used to indicate.)

⑧ - 2digits : Color / chromaticity rank

(If color / chromaticity rank is 1 digit, "-" shall be dashed on the place for the second digit.
If there is no identified intensity rank, "- -" is used to indicate.)

⑨ - 1digit : Option rank (Stanley normally print "-" to indicate)

This product is in compliance with RoHS2 / ELV.

Prohibition substance and it's criteria value of RoHS2 / ELV are as follows.

- RoHS2 instruction ... Refer to following 1 to 10.
- ELV instruction ... Refer to following 1 to 4.

No.	Substances	Thlreshold
1	Lead and its compounds	0.1% (1,000ppm)
2	Mercury and its compounds	0.1% (1,000ppm)
3	Cadmium and its compounds	0.01% (100ppm)
4	Hexavalent chromium compounds	0.1% (1,000ppm)
5	PBB : Polybrominated Biphenyls	0.1% (1,000ppm)
6	PBDE : Polybrominated Biphenyl Ethers	0.1% (1,000ppm)
7	DEHP : Bis (2-ethylhexyl) phthalate	0.1% (1,000ppm)
8	BBP : Butyl benzyl phthalate	0.1% (1,000ppm)
9	DBP : Dibutyl phthalate	0.1% (1,000ppm)
10	DIBP : Diisobutyl phthalate	0.1% (1,000ppm)

Reliability testing result

VCKW1151CDS-3C6L3-TR

1. Reliability testing result

Test item	Standard	Test condition	Duration	Failure
Operating life	EIAJ ED-4701 /100(101)	Ta=25°C Maximum rated current	1,000h	0 / 20
High temperature operating life	EIAJ ED-4701 /100(101)	Ta=85°C Maximum rated current ※1	1,000h	0 / 20
Low temperature operating life	EIAJ ED-4701 /100(101)	Ta=-40°C Maximum rated current	1,000h	0 / 20
Wet high temperature operating life	EIAJ ED-4701 /100(102)	Ta=60°C Rh=90% Maximum rated current	1,000h	0 / 20
High temperature storage life	EIAJ ED-4701 /200(201)	Ta = Tstg max. Maximum storage temperature	1,000h	0 / 20
Low temperature storage life	EIAJ ED-4701 /200(202)	Ta = Tstg min. Minimum storage temperature	1,000h	0 / 20
Wet high temperature storage life	EIAJ ED-4701 /100(101)	Ta=60°C Rh=90%	1,000h	0 / 20
Thermal shock	EIAJ ED-4701 /100(105)	Ta= Tstg max. ~ Tstg min. (each 15min)	1,000 cycles	0 / 20
Resistance to reflow soldering	EIAJ ED-4701 /300(301)	Moisture soak : 60°C 60% 121h Preheating : 150~180°C 90~120s Soldering : 260°C 5sec	2 times	0 / 20
Electric Static Discharge(ESD) ※2	EIAJ ED-4701 /300(304)	C=100pF R2=1.5kΩ ±2,000V	3 times of each polarity	0 / 10
Vibration, variable frequency	EIAJ ED-4701 /400(403)	98.1m/s ² (10G) 100~2,000Hz 20min sweep XYZ direction	2h of each direction	0 / 10

※1 Maximum rated current at maximum rated operating temperature

※2 Reference test

2. Failure criteria

Item	Symbol	Condition	Failure criteria
Luminous intensity	I _V	I _F =20mA	Testing min. value < standard min. value × 0.5
Forward voltage	V _F	I _F =20mA	Testing max. value ≥ standard max. value × 1.2
Reverse current	I _R	V _R =5V	Testing max. value ≥ standard max. value × 2.5
External appearance	-	-	Notable decoloration, deformation and cracking

Special notice to customers using the products and technical information shown in this data sheet

- 1) The technical information shown in the data sheets are limited to the typical characteristics and circuit examples of the referenced products. It does not constitute the warranting of industrial property nor the granting of any license.
- 2) For the purpose of product improvement, the specifications, characteristics and technical data described in the data sheets are subject to change without prior notice. Therefore it is recommended that the most updated specifications be used in your design.
- 3) When using the products described in the data sheets, please adhere to the maximum ratings for operating voltage, heat dissipation characteristics, and other precautions for use. We are not responsible for any damage which may occur if these specifications are exceeded.
- 4) The products that have been described to this catalog are manufactured so that they will be used for the electrical instrument of the benchmark (OA equipment, telecommunications equipment, AV machine, home appliance and measuring instrument).
The application of aircrafts, space borne application, transportation equipment, medical equipment and nuclear power control equipment, etc. needs a high reliability and safety, and the breakdown and the wrong operation might influence the life or the human body. Please consult us beforehand if you plan to use our product for the usages of aircrafts, space borne application, transportation equipment, medical equipment and nuclear power control equipment, etc. except OA equipment, telecommunications equipment, AV machine, home appliance and measuring instrument.
- 5) In order to export the products or technologies described in this data sheet which are under the “Foreign Exchange and Foreign Trade Control Law,” it is necessary to first obtain an export permit from the Japanese government.
- 6) No part of this data sheet may be reprinted or reproduced without prior written permission from Stanley Electric Co., Ltd.
- 7) The most updated edition of this data sheet can be obtained from the address below:
<http://www.stanley-components.com/en>